



**POLITEKNIK KESEHATAN  
TANJUNG KARANG**

**NAMA / NIM**

**INDRIANSYAH ZAINI  
UMAR  
231335167**

**PROGRAM STUDI**

**D4 SANITASI LINGKUNGAN**

**DOSEN PEMBIMBING**

Pembimbing 1

**Dr.Ferizal Masra,SKM,M.Kes**

Pembimbing 2

**Zainal Muslim, SKM,M.Kes**

**NAMA GAMBAR**

Instalasi pengolahan air limbah  
Puskesmas rawat jalan kedaloman

**KETERANGAN ACC**

SKALA	JUMLAH GAMBAR	NO. GAMBAR
1 : 50		02

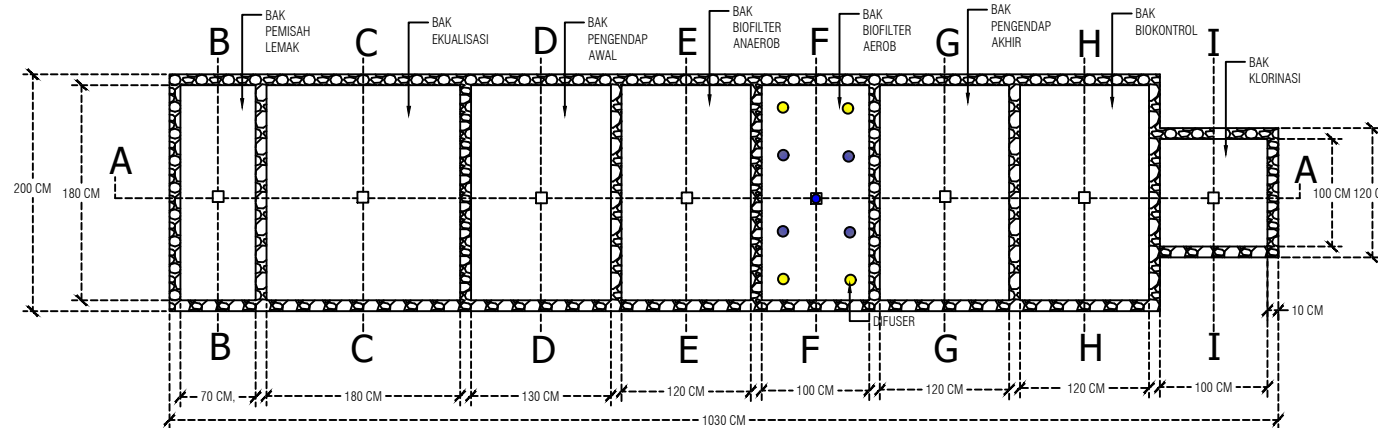

**DENAH INSTALSI PENGOLAHAN AIR LIMBAH**





**POLITEKNIK KESEHATAN  
TANJUNG KARANG**

**NAMA / NIM**

**INDRIANSYAH ZAINI  
UMAR  
231335167**

**PROGRAM STUDI**

**D4 SANITASI LINGKUNGAN**

**DOSEN PEMBIMBING**

Pembimbing 1

**Dr.Ferizal Masra,SKM,M.Kes**

Pembimbing 2

**Zainal Muslim, SKM,M.Kes**

**NAMA GAMBAR**

Instalasi pengolahan air limbah  
Puskesmas rawat jalan kedaloman

**KETERANGAN ACC**

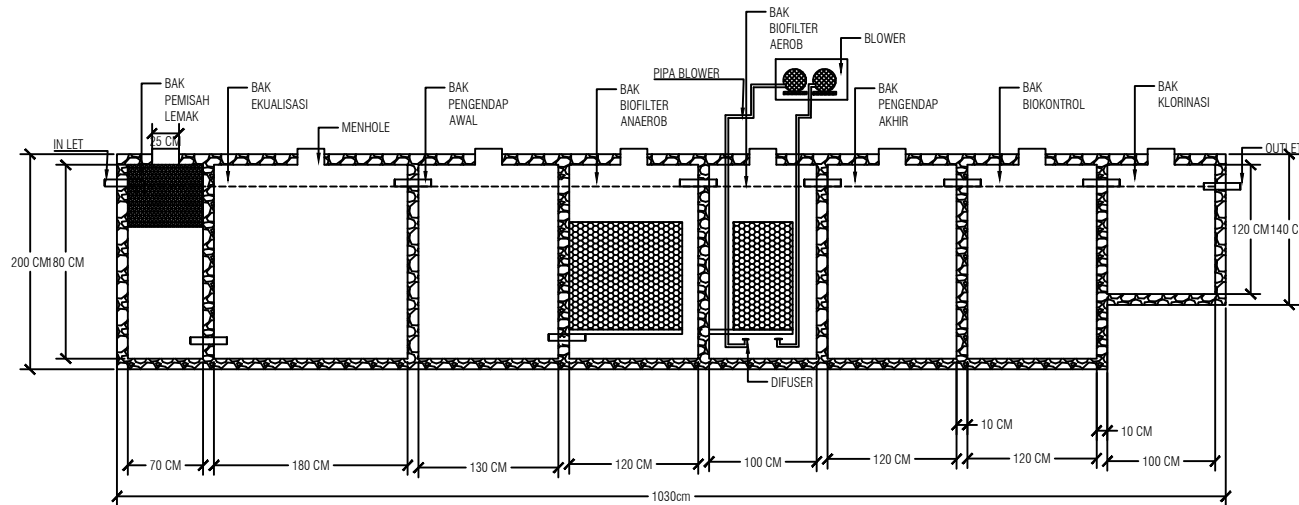

**POTONGAN A-A**



SKALA

JUMLAH  
GAMBAR

NO.  
GAMBAR

1 : 50

02



POLITEKNIK KESEHATAN  
TANJUNG KARANG

NAMA / NIM

INDRIANSYAH ZAINI  
UMAR  
231335167

PROGRAM STUDI

D4 SANITASI LINGKUNGAN

DOSEN PEMBIMBING

Pembimbing 1

Dr.Ferizal Masra,SKM,M.Kes

Pembimbing 2

Zainal Muslim, SKM,M.Kes

NAMA GAMBAR

Instalasi pengolahan air limbah  
Puskesmas rawat jalan kedaloman

KETERANGAN ACC

SKALA	JUMLAH GAMBAR	NO. GAMBAR
1 : 50	06	03

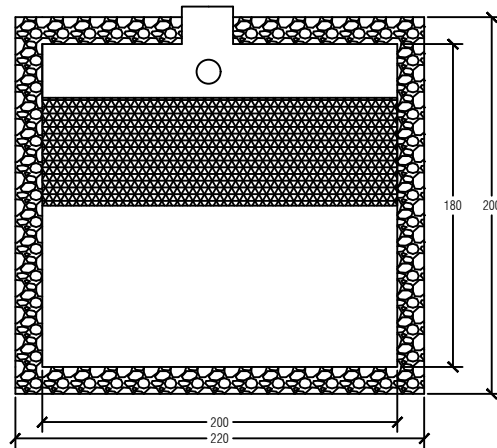

POTONGAN B-B  
BAK PEMISAH LEMAK

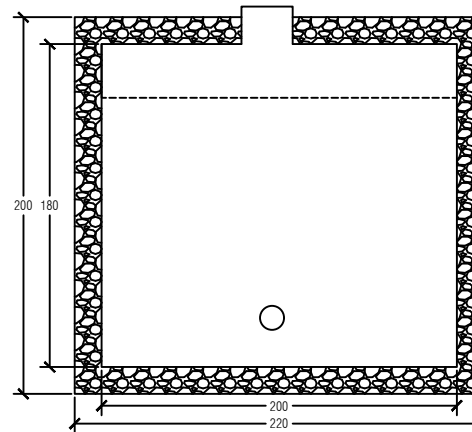

POTONGAN C-C  
BAK EKUALISASI



POLITEKNIK KESEHATAN  
TANJUNG KARANG

NAMA / NIM

INDRIANSYAH ZAINI  
UMAR  
231335167

PROGRAM STUDI

D4 SANITASI LINGKUNGAN

DOSEN PEMBIMBING

Pembimbing 1

Dr.Ferizal Masra,SKM,M.Kes

Pembimbing 2

Zainal Muslim, SKM,M.Kes

NAMA GAMBAR

Instalasi pengolahan air limbah  
Puskesmas rawat jalan kedaloman

KETERANGAN ACC

SKALA	JUMLAH GAMBAR	NO. GAMBAR
1 : 50	06	04

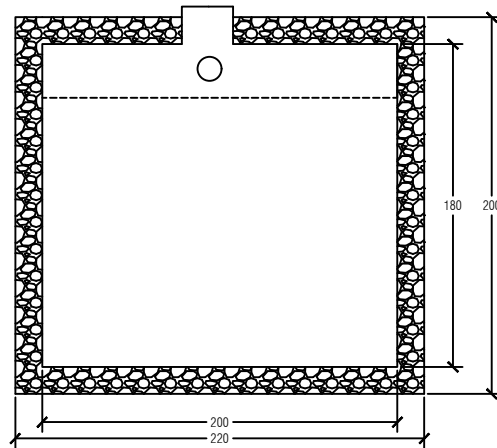

POTONGAN D-D  
BAK BIOKONTROL

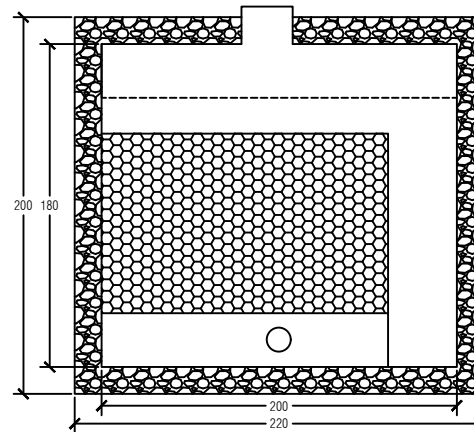

POTONGAN E-E  
BAK ANAEROB



POLITEKNIK KESEHATAN  
TANJUNG KARANG

NAMA / NIM

INDRIANSYAH ZAINI  
UMAR  
231335167

PROGRAM STUDI

D4 SANITASI LINGKUNGAN

DOSEN PEMBIMBING

Pembimbing 1

Dr.Ferizal Masra,SKM,M.Kes

Pembimbing 2

Zainal Muslim, SKM,M.Kes

NAMA GAMBAR

Instalasi pengolahan air limbah  
Puskesmas rawat jalan kedaloman

KETERANGAN ACC

SKALA	JUMLAH GAMBAR	NO. GAMBAR
1 : 50	06	05

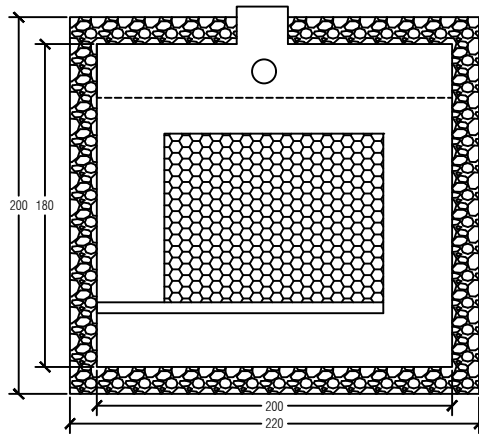

POTONGAN F-F  
BAK AEROB

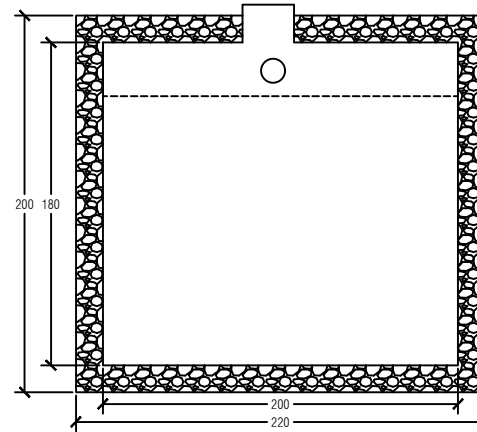

POTONGAN G-G  
BAK PENGENDAP AKHIR



POLITEKNIK KESEHATAN  
TANJUNG KARANG

NAMA / NIM

INDRIANSYAH ZAINI  
UMAR  
231335167

PROGRAM STUDI

D4 SANITASI LINGKUNGAN

DOSEN PEMBIMBING

Pembimbing 1

Dr.Ferizal Masra,SKM,M.Kes

Pembimbing 2

Zainal Muslim, SKM,M.Kes

NAMA GAMBAR

Instalasi pengolahan air limbah  
Puskesmas rawat jalan kedaloman

KETERANGAN ACC

SKALA	JUMLAH GAMBAR	NO. GAMBAR
1 : 50	06	06

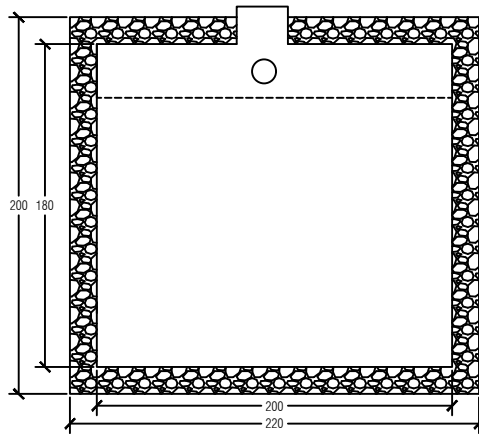

POTONGAN H-H  
BAK BIOKONTROL

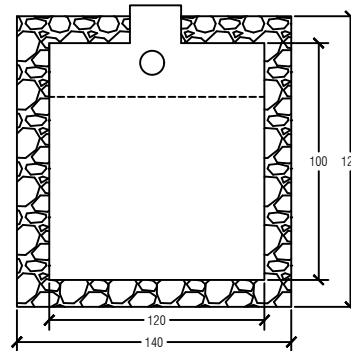

POTONGAN I-I  
BAK KLORINASI



**POLITEKNIK KESEHATAN  
TANJUNG KARANG**

**NAMA / NIM**

**INDRIANSYAH ZAINI  
UMAR  
231335167**

**PROGRAM STUDI**

**D4 SANITASI LINGKUNGAN**

**DOSEN PEMBIMBING**

Pembimbing 1

**Dr.Ferizal Masra,SKM,M.Kes**

Pembimbing 2

**Zainal Muslim, SKM,M.Kes**

**NAMA GAMBAR**

Instalasi pengolahan air limbah  
Puskesmas rawat jalan kedaloman

**KETERANGAN ACC**

SKALA	JUMLAH GAMBAR	NO. GAMBAR
1 : 50	06	06

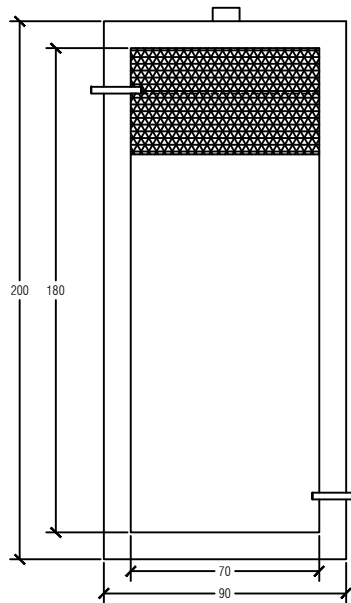

**POTONGAN B-B  
BAK PEMISAH LEMAK**

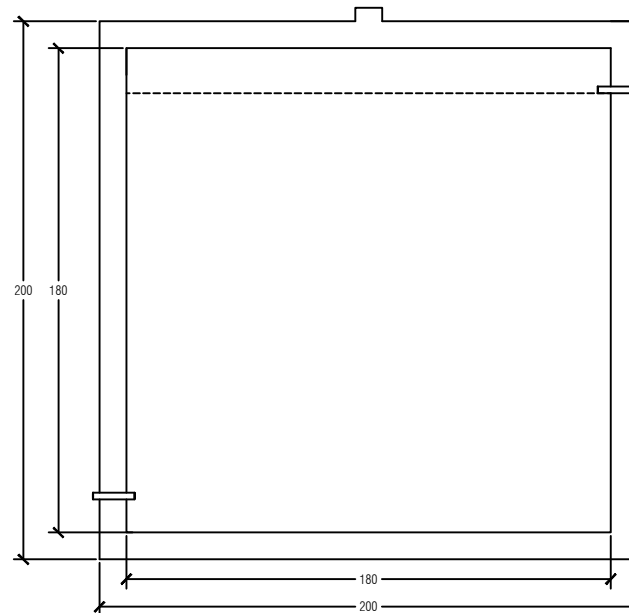

**POTONGAN C-C  
BAK EKUALISASI**



POLITEKNIK KESEHATAN  
TANJUNG KARANG

NAMA / NIM

INDRIANSYAH ZAINI  
UMAR  
231335167

PROGRAM STUDI

D4 SANITASI LINGKUNGAN

DOSEN PEMBIMBING

Pembimbing 1

Dr.Ferizal Masra,SKM,M.Kes

Pembimbing 2

Zainal Muslim, SKM,M.Kes

NAMA GAMBAR

Instalasi pengolahan air limbah  
Puskesmas rawat jalan kedaloman

KETERANGAN ACC

SKALA	JUMLAH GAMBAR	NO. GAMBAR
1 : 50	06	05

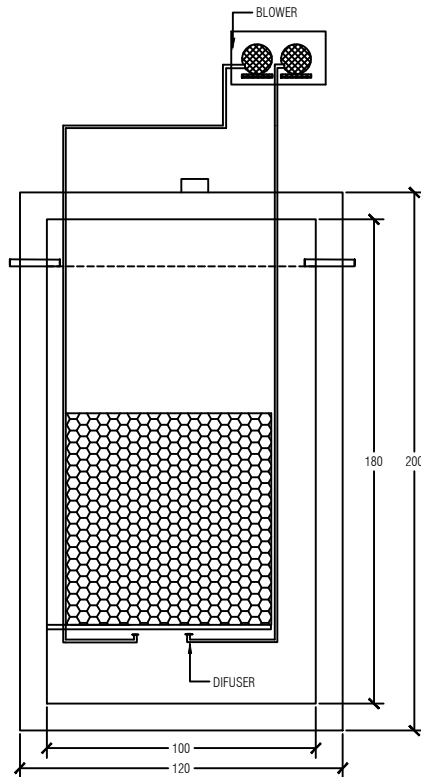

POTONGAN F-F  
BAK AEROB

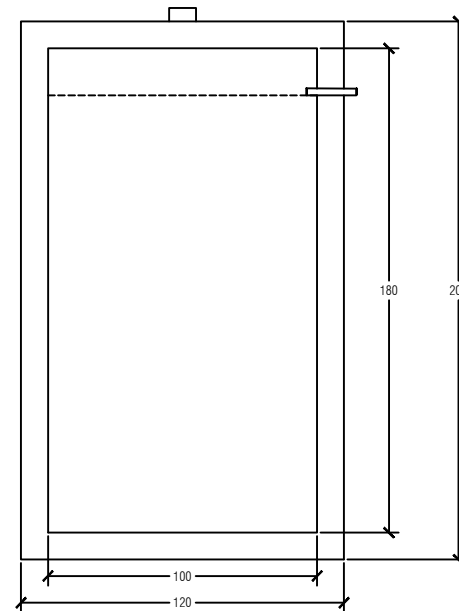

POTONGAN G-G  
BAK PENGENDAP AKHIR





POLITEKNIK KESEHATAN  
TANJUNG KARANG

NAMA / NIM

INDRIANSYAH ZAINI  
UMAR  
231335167

PROGRAM STUDI

D4 SANITASI LINGKUNGAN

DOSEN PEMBIMBING

Pembimbing 1

Dr.Ferizal Masra,SKM,M.Kes

Pembimbing 2

Zainal Muslim, SKM,M.Kes

NAMA GAMBAR

Instalasi pengolahan air limbah  
Puskesmas rawat jalan kedaloman

KETERANGAN ACC

SKALA	JUMLAH GAMBAR	NO. GAMBAR
1 : 50	06	05

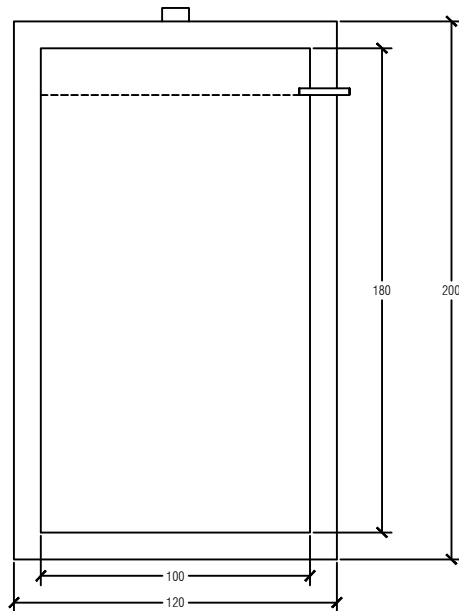

POTONGAN F-F  
BAK AEROB

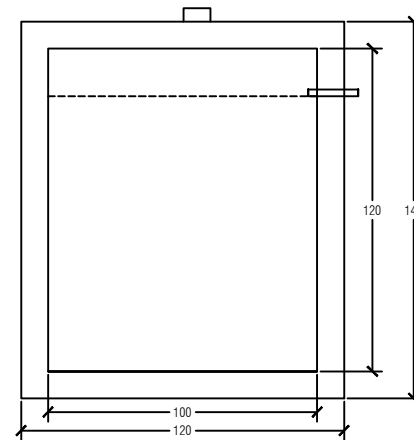

POTONGAN G-G  
BAK PENGENDAP AKHIR